

**0446** T-handle offset screwdriver, TORX<sup>®</sup>, TX 50, MATADOR item no.: 04460500

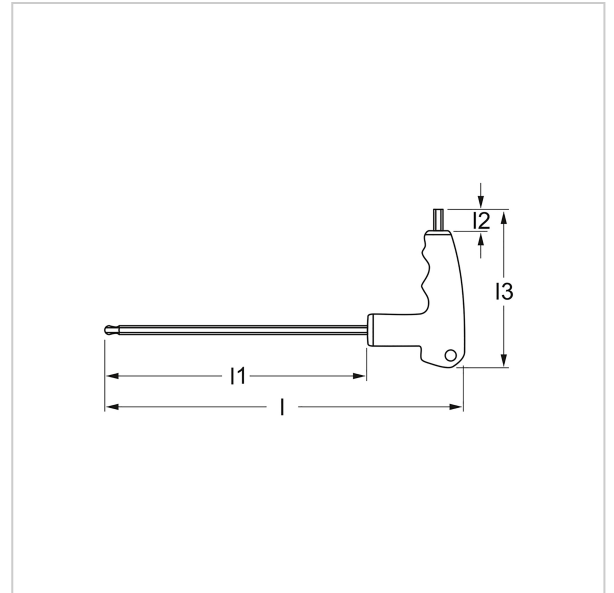

**0446** T-handle offset screwdriver, TORX<sup>®</sup>, TX 50, MATADOR item no.: 04460500

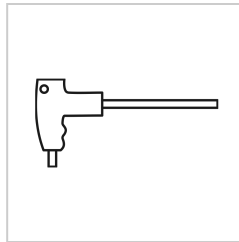

**Beschreibung:**

**T-handle angle screwdriver for internal TORX<sup>®</sup> screws.**

Particularly **flexible and effective** in different space conditions. Should not be missing in any tool set. **Long side with ball head** at the end for fast screwing, **short side for powerful screwdriving**. Also ideal for screws that are difficult to access, as ball head **can be swivelled up to 25°**. With particularly ergonomic **2-component handle** with hard quick rotation and soft force zone made of TPE plastic. Fits perfectly in the hand due to a particularly ergonomic handle shape. This makes screws fun. With fully **hardened blade**, fully galvanic treatment of the surface (nickel-plated and chrome-plated) for long-lasting **corrosion protection**. Special **chromium vanadium alloy** for transmitting high torque values.

**Technische Daten**

<b>Manufacturer-Number:</b>	04460000M
<b>Width:</b>	80 mm
<b>Height:</b>	15 mm
<b>Length:</b>	145 mm
<b>Weight:</b>	0.024 kg

**0446** T-handle offset screwdriver, TORX<sup>®</sup>, TX 50, MATADOR item no.: 04460500